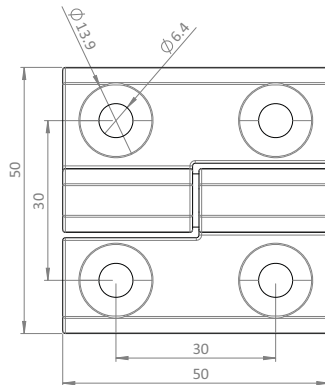
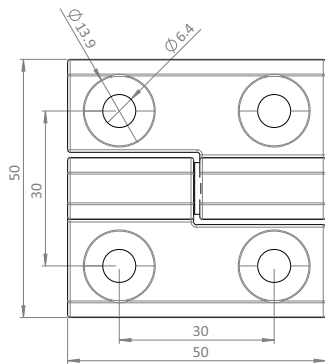
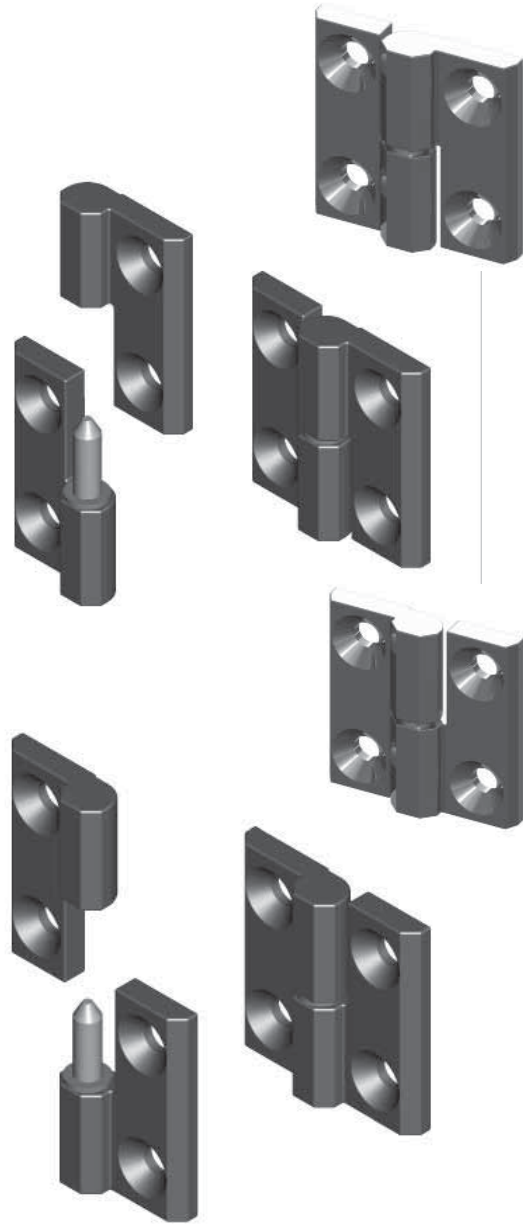

DESCRIPTION	To hinge panels
MATERIAL	Hinge leaves: Die-cast zinc Hinge pin: 304 SS
SURFACE	Hinge leaves: Black powder coat, Chrome Plated
HARDWARE	M6 Flat Head Screw

LEFT VERSION

RIGHT VERSION

Version

Black Powder Coated

Chrome Plated

Left

SOHBL272
SOHCL272S01

Right

SOHBR273
SOHCR273S01