

01-13-6 SERIES

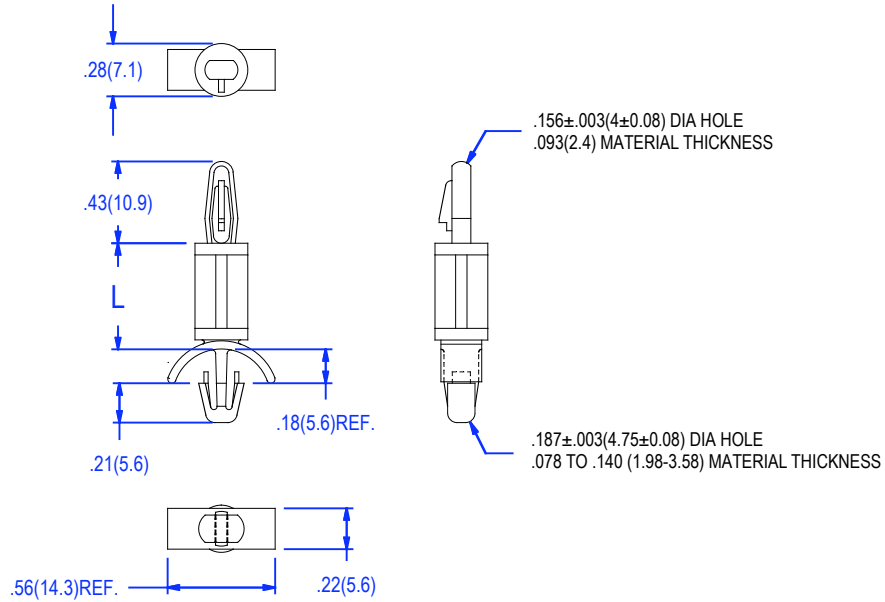

ITEM NO.	L	
	In. +/- .015	mm. ± 0.4
01-13 -6 -30	.187	4.8
01-13 -6 -40	.250	6.4
01-13 -6 -50	.312	7.9
01-13 -6 -60	.375	9.5
01-13 -6 -70	.437	11.1
01-13 -6 -80	.500	12.7
01-13 -6 -100	.625	15.9
01-13 -6 -120	.750	19.1
01-13 -6 -140	.875	22.2
01-13 -6 -160	1.00	25.4
01-13 -6 -180	1.122	28.6
01-13 -6 -200	1.25	31.7
01-13 -6 -220	1.375	34.9

- NOTES:
 1. PACKAGING : 1000 PER BAG.
 2. V-O RATED NYLON AVAILABLE ON REQUEST.
 TO ORDER ADD SUFFIX "X" TO ITEM NUMBER

MATERIAL	NYLON 66
UL RATING	94V-2
UL FILE NO.	E41938
COLOR	NATURAL
ASTM	D 4066, PA111
RoHS COMPLIANCE	YES
TEMPERATURE RANGE (REF.)	-40 to 185°F (-40 to 85°C)
MR NUMBER	12

				ALL ELECTRONICS HARDWARE , INC.		Title		PCB SUPPORT		Issue	
				2642 CORPORATE PARKWAY						0	
				ALGONQUIN, IL. 60102		File No.		01136seriesCT		Date	
No	Revision	Date	Init	1-800-778-7234						01/14/09	